



GENERATOR



1.8L / 3 CYLINDERS



SWITCHABLE



EPA/CARB TIER4F

DESCRIPTION

- HD Construction Equipment's compact electronic engines, DP023C- Series is one of the key products.
- When compared to other engines of equivalent capacity, it displays a higher output, better fuel efficiency, higher safety, and easier maintenance.
- It has been recognized in the market even with the high emission standard EPA/CARB Tier4F and satisfied its customers.



FEATURES & BENEFITS

[Low Emission]

- Meet EPA Tier 4 Final without DPF system

[Performance & Fuel Economy Improvement]

- Bosch 1,800bar common rail system
- Ultra low fuel consumption
- Air management improved through optimization of valve timing & turbocharger matching

[Convenience & TCO]

- Maintenance free for valve clearance
- Auto tensioner belt drive system
- Oil level sensor option for 1,000hrs exchange interval

OUTPUT

| 1,500 RPM (50Hz) | | | | | | | | | 1,800 RPM (60Hz) | | | | | | | | |
|------------------|------|------|-------|------|------|------------|------|------|------------------|------|------|-------|------|------|------------|------|------|
| Standby | | | Prime | | | Continuous | | | Standby | | | Prime | | | Continuous | | |
| kWm | kWe | kVA | kWm | kWe | kVA | kWm | kWe | kVA | kWm | kWe | kVA | kWm | kWe | kVA | kWm | kWe | kVA |
| 30.2 | 26.1 | 32.6 | 27.2 | 23.4 | 29.3 | 19.0 | 16.2 | 20.3 | 38.1 | 32.6 | 40.8 | 34.3 | 29.3 | 36.6 | 24.0 | 20.2 | 25.2 |

- Generator efficiency (typical) : 88.0%
- kWm= kilo Watt mechanical, Gross power; kWe= kilo Watt electric = (kWm-Fan loss) x Generator eff.
kVA= kilo Volt Ampere
- Calculations based on a 0.8 power factor = kWe/0.8

DP023CAP

GENERAL DATA

| | |
|-----------------------------|---|
| Type | Diesel, Water cooled, Turbo charged & Intercooled |
| Bore | 90mm |
| Stroke | 94mm |
| Displacement liter | 1.79 |
| Cylinders and Arrangement | Cast iron, 3 cylinder, In-line Type |
| Battery charging alternator | 12V x 110A |
| Starting voltage | 12V |
| Fuel system | Common Rail, Direct Injection Controlled by ECU |
| Fuel filter | Full flow, cartridge type |
| Lube oil filter type (s) | Full flow, cartridge type |
| Lube oil capacity (l) | Max. 6.3 liters , Min. 2.8 liters |
| Flywheel dimensions | Clutch 10"(SAE J620) |

COOLING SYSTEM

| | | |
|---|--------------------------------|------------|
| Cooling method | Fresh water forced circulation | |
| Cooling ratio | 50% ethylene glycol; 50% water | |
| Water capacity (L) | with radiator | 8.4 liters |
| | Without radiator | 3.1 liters |
| Fan power (kW) | 0.6 kW (50Hz), 1.1 kW (60Hz) | |
| Cooling system air flow (m ³ /min) | - | |

FUEL CONSUMPTION

| 1,500 RPM (50Hz) | | |
|-------------------|------|-----------|
| % | kWm | Liters/hr |
| Standby | | |
| 100 | 30.2 | - |
| Prime | | |
| 100 | 27.2 | - |
| 75 | 20.4 | - |
| 50 | 13.6 | - |
| 25 | 6.8 | - |
| Continuous | | |
| 100 | 19.0 | - |

| 1,800 RPM (60Hz) | | |
|-------------------|------|-----------|
| % | kWm | Liters/hr |
| Standby | | |
| 100 | 38.1 | 10.1 |
| Prime | | |
| 100 | 34.3 | 10.0 |
| 75 | 25.7 | 7.5 |
| 50 | 17.1 | 5.2 |
| 25 | 8.6 | 2.9 |
| Continuous | | |
| 100 | 24.0 | - |

DP023CAP

DIMENSIONS

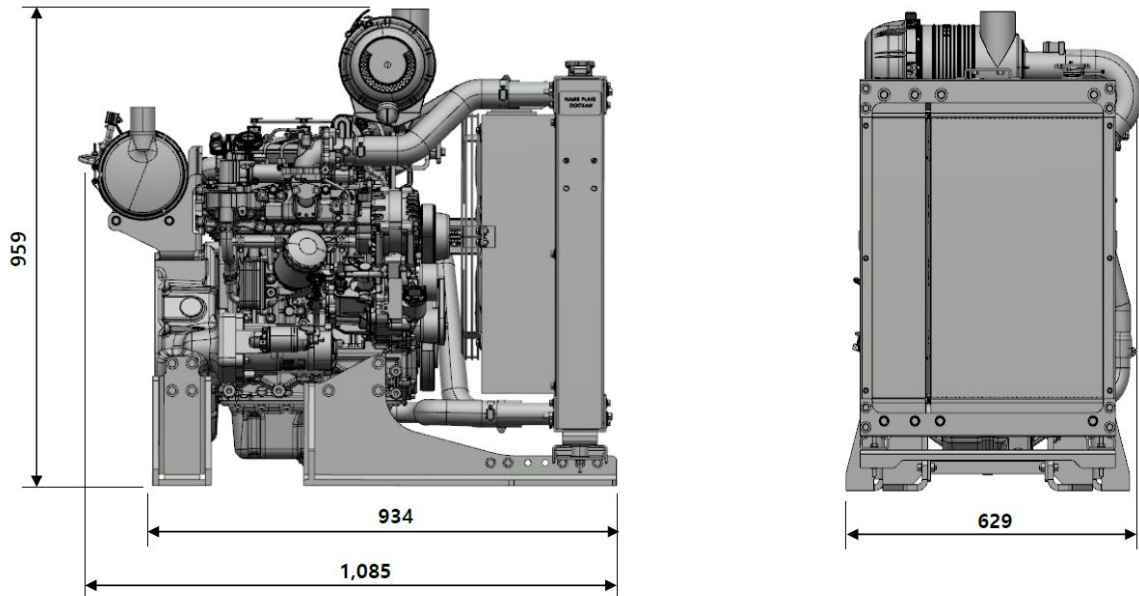

Weights and Dimensions

| Item | Length (mm) | Width (mm) | Height (mm) | Dry Weight (kg) |
|-----------------|-------------|------------|-------------|-----------------|
| Engine with ATS | 740 | 567 | 770 | 220 |
| G-Pack | 1,085 | 629 | 959 | 310 |

POWER RATING GUIDE

The power ratings of Emergency Standby and Prime are in accordance with ISO 8528. Fuel Stop power in accordance with ISO 3046. Electric power (kWe) must be considered cooling fan loss, alternator efficiency, altitude derating and ambient temperature.

ESP(STANDBY POWER) is applicable for supplying emergency power for the duration of the utility power outage. No overload capability is available for this rating. A standby rated engine should be sized for a maximum of an 70% average load factor and 200 hours of operation per year. This includes less than 25 hours per year at the Standby Power rating.

PRP(PRIME POWER) is available for an unlimited number of hours per year in variable load application. Variable load should not exceed a 70% average of the Prime Power rating during any operating period of 24 hours. The Total operating time at 100% Prime Power shall not exceed 500 hours per year. A 10% overload capability is available for a period of 1 hour within a 12 hours period of operation. Total operating time at the 10% overload power shall not exceed 25 hours per year.

COP(CONTINUOUS POWER) is defined as being the maximum power which the generating set is capable of delivering continuously whilst supplying a constant electrical load when operated for an unlimited number of hours per year under the agreed operating conditions with the maintenance intervals and procedures being carried out as prescribed by the manufacturer.

※ Specifications are subject to change without prior notice.